

Current part is item (12) on diagram. Available at www.oshkoshequipment.com

(1) (a) FIG. NO.	(2) (b) ITEM NO.	(3) SMR CODE	(4) NATIONAL STOCK NUMBER	(5) PART NUMBER	(6) DESCRIPTION FSCM USABLE ON CODE	(7) U/M	(8) INC IN UNIT
GROUP 1202-SERVICE BRAKES							
114	1	KFOZZ		MS51968-5	96906 NUT: PIN TO BACKING PLATE (PART OF KIT, P/N 8332057)	EA	24
114	2	KFOZZ		MS35338-45	96906 WASHER, LOCK: PIN TO BACKING PLATE (PART OF KIT, P/N 8332057)	EA	24
114	3	KFOZZ		8331244	19207 WASHER: UPPER (PART OF KIT, P/N 8332057)	EA	12
114	4	KFOZZ		8331242	19207 PIN: LONG (PART OF KIT, P/N 8332057)	EA	12
114	5	KFOZZ		8331245	19207 WASHER: LOWER (PART OF KIT, P/N 8332057)	EA	12
114	6	KFOZZ		8331243	19207 PIN: SHORT (PART OF KIT, P/N 8332057)	EA	12
114	7	PAOZZ	5360-00-813-7813	10896716	19207 SPRING, HELICAL COMPRESSION: BRAKESHOE	EA	12
114	8	PAOZZ	2530-00-274-4511	7411010	19207 CYLINDER ASSEMBLY, HYDRAULIC BRAKE, WHEEL (SEE FIG 115)	EA	6
114	9	XBOZZ		7372762	19207 SHIELD	EA	4
114	10	PAOZZ	2530-00-753-9270	7539270	19207 ROD, WHEEL CYLINDER	EA	8
114	11	PAOZZ	5360-002-741-1017	10896707	19207 SPRING, HELICAL, EXTENSION: SHOE RETRACTING	EA	6
114	12	PAOFF	2530-00-752-1767	7521767	19207 SHOE BRAKE, INTERNALLY ACTUATED: W/LINING	EA	12
114	16	XBOZZ		10896682	19207 RETAINER, SLOTTED: SHOE ANCHOR PIN	EA	12
114	17	PAOZZ	5310-00-252-2130	10896709	19207 WASHER, FLAT: SHOE ANCHOR PIN	EA	12
114	18	PAOZZ	5330-00-168-5673	10896683	19207 WASHER, RECESSED: SHOE ANCHOR PIN FELT WASHER	EA	12
114	19	XBOZZ		10896712	19207 FELT WASHER: FIRM WASHER, GRAY, THK 1/4 INCH W 12 IN. LONG 36 INCH	EA	12
114	20	PAOZZ	5315-00-451-1047	10896681	19207 PIN, ANCHOR: SHOE	EA	12
114	21	PAOZZ	2530-00-752-1766	7521766	19207 DEFLECTOR ASSEMBLY	EA	6
114	22	PAOZZ	2530-00-512-4974	5124974	19207 CAM BRAKESHOE: ADJUSTING	EA	12
114	23	PAOZZ	5360-00-292-3004	5160339	19207 SPRING, HELICAL, COMPRESSION: BRAKESHOE ADJUSTING CAM	EA	12
114	24	PAOZZ	2530-00-026-0187	7521733	19207 STUD, WITH WASHER: ADJUSTING CAM	EA	12
114	25	XBOZZ		7699794	19207 SHIELD ASSEMBLY, BRAKE: DUST BRAKE	EA	6
114	26	PAOZZ	5310-00-763-8901	MS51968-23	96906 NUT, PLAIN, HEXAGON: ANCHOR PIN	EA	12
114	27	PAOZZ	5310-00-584-7888	MS35338-51	96906 WASHER, LOCK: ANCHOR PIN	EA	12
114	28	PAOZZ	5305-00-269-3210	MS90725-59	96906 SCREW, CAP, HEXAGON HEAD	EA	12

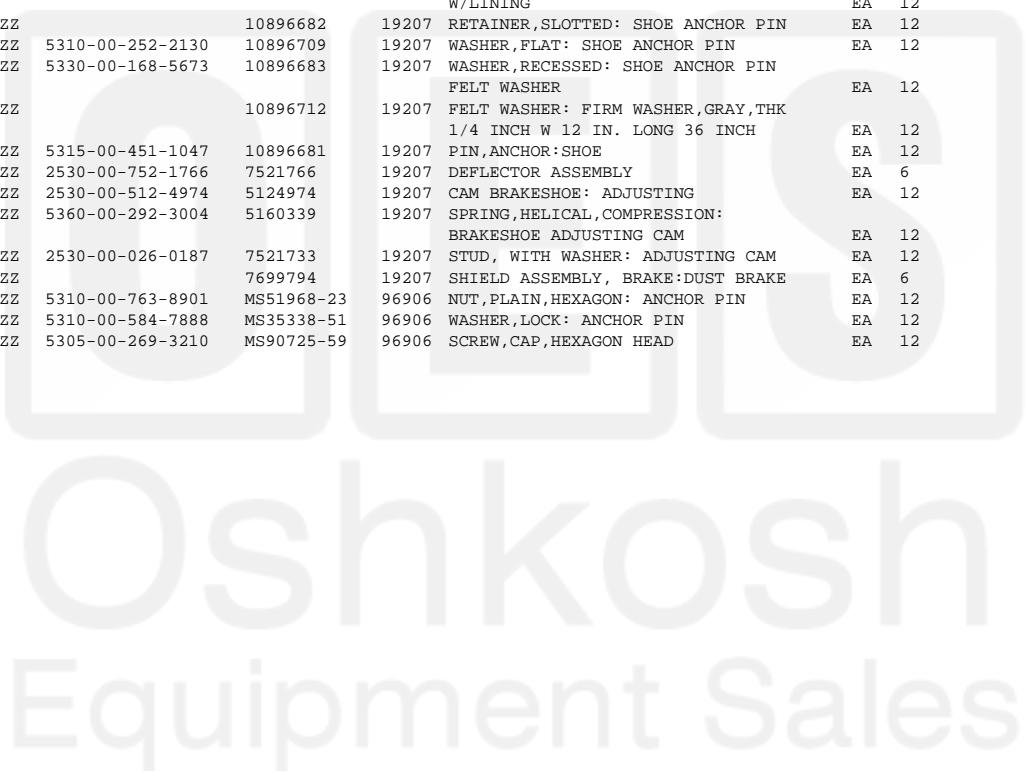

Current part is item (12) on diagram. Available at www.oshkoshequipment.com

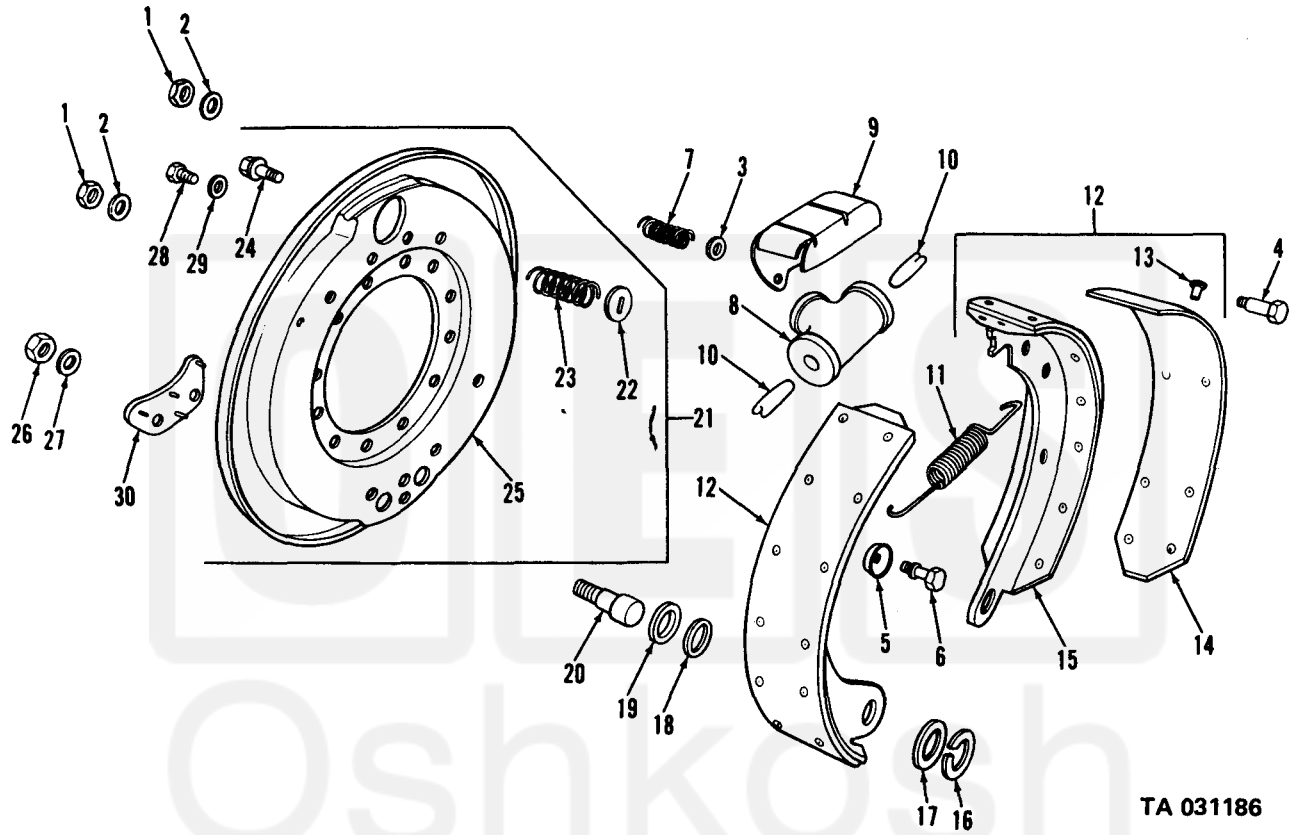

TA 031186

Figure 114. Service brake assembly.